

2024 HANKOOK TIRE

# Warranty Booklet

Truck & Bus Tires

United States of America



# TBR

## Truck and Bus Radial Tire

### Contents

---

Important Safety Warning .....	3
Limited Warranty .....	15
Claim Adjustment Procedure.....	17
Claim Form Sample .....	19
Freight Policy / General Terms & Policies ....	21
Credit Percentage Table 1 .....	22
Credit Percentage Table 2 .....	23
Load Inflation Pressure Tables .....	24
Load Inflation Pressure Tables .....	25

### NOTES

---

- T/L : Tubeless Type
- M+S : Mud & Snow
- UMS : Ultra Mileage & Safety
- 3PMSF : Three Peak Mountain Snowflake

This List cancels all previous lists and is subject to change without prior notice



# Important Safety Warning

For your safety and protection against serious injury or death, the following safety precaution and maintenance instruction must be observed at all times.

## PREFACE

This information is provided to help Hankook Tire Truck & Bus customers achieve safe, economical use of our products and maximize tire life.

The purchase of truck and bus tires should be looked at as an investment to be protected by the thorough maintenance and care in order to produce the best return on your investment and fleet operating efficiency. Information covered in this manual covers how to perform regular tire inspections, tire servicing and repairs as well as how to safely mount and demount tires.

Careful attention on a regular basis can provide you with added safety and economy.

We hope the information is helpful to all the tire servicemen and fleet operators.

## DETERMINING TIRE SIZE

There is a lot of useful information molded into the sidewall of every tire, included are the manufacturer and tire name, section width, aspect ratio, construction, rim diameter, speed rating, load range, treadwear, temperature and traction labeling and other required designations.

### CORRESPONDING SIZES FOR TUBE-TYPE AND TUBELESS

To achieve the closest match of load carrying capacity, overall diameter and section width see the following chart.

#### LOW PROFILE TIRES

Low profile tires are marked according to ISO standards with

Tube-Type	Tubeless
7.50 R 20	8 R 22.5
8.25 R 15	9 R 17.5
8.25 R 20	9 R 22.5
9.00 R 20	10 R 22.5
10.00 R 20	11 R 22.5
10.00 R 22	11 R 24.5
11.00 R 20	12 R 22.5
12.00 R 20	12 R 22.5

Section widths and rim diameters will vary slightly between tubeless and tube-type assemblies. While the measurements seem close, users should be careful not to confuse them.

additional symbols for load range and maximum speed.

Low profile tires provide additional benefits such as:

- Fuel savings
- Increased load carrying capacity
- Improved retreadability
- Improved cornering ability
- Braking improvement

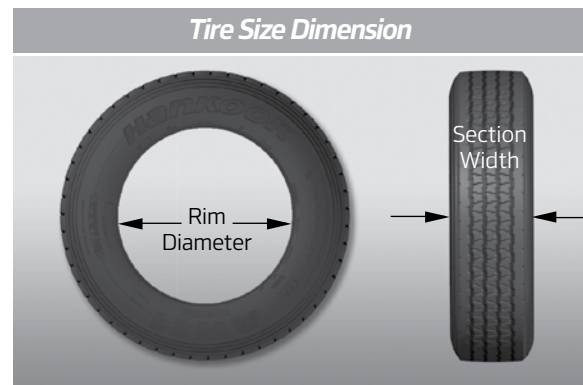

295/75 R22.5	Size Description
295	Tire section width (mm)
75	Aspect ratio (Section Height / Section width)
R	Radial structure
22.5	Rim diameter (inch)
14	Ply rating
L	Tire Max. driving speed symbol

### Outside diameter comparison

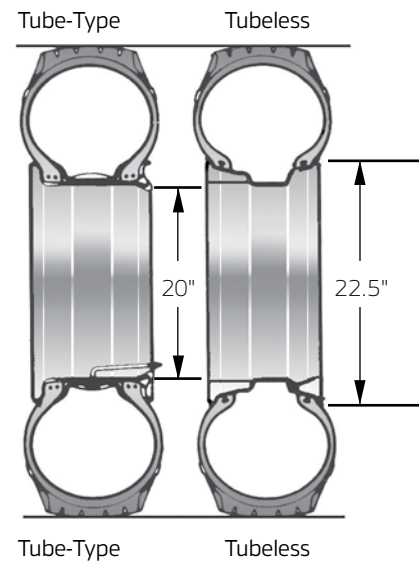

Disregarding any of the safety precautions and instructions contained in this information sheet may result in tire failure or explosion causing serious personal injury or death.

## TRUCK TIRE MARKINGS

All truck tires are marked representing their structure, construction type, dimensions and manufacturer/brand. In addition, they should carry the U. S. Department of Transport code and/or ISO symbols. Below is a typical Hankook tire that illustrates the ISO markings.

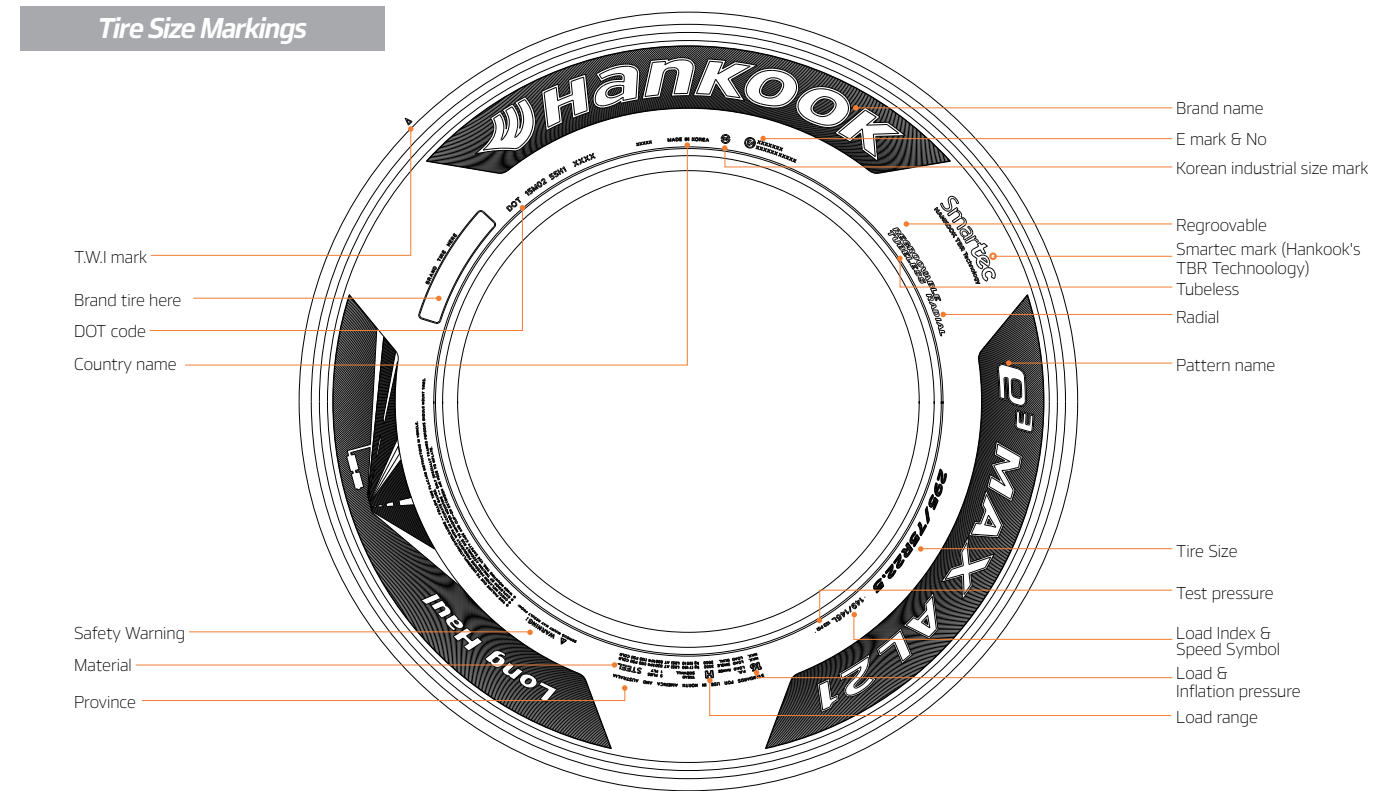

### SAFETY WARNING

Serious injury may result from:

- Tire failure due to under inflation or overloading - Follow the tire placard instruction on the vehicle and check inflation pressures frequently.
- Due to improper mounting - Only specifically trained persons should mount tires. Follow all safety procedures and inflate using a safety cage and a remote clip-on extension hose.

### LOAD INDEX & SPEED SYMBOL

**WARNING** It is recommended that the replacement tire speed rating be equal to or greater than the OEM tire speed rating. If a lower speed rated tire is selected, then the vehicle top speed becomes limited to that of the lower speed rating selected. The customer must be informed of the new speed restriction & the vehicle's handling may be adversely impacted.

When replacing tires, consult the placard or the owner's manual for correct size and speed rating. The speed rating of the replacement tires must be equal to or greater than the speed rating of the tire being replaced to maintain the speed capability of the vehicle. Speed ratings do not imply that the vehicle can be safely driven at the maximum speeds for which the tire is rated. Serious injury or death may take place if you drive your vehicle in an unsafe or unlawful manner. Hankook's speed symbol designations are verified and comply with regulatory indoor test in accordance with ECE-R30,54 test (Economic council for Europe : Procedure Load / Speed performance test for tires). These symbols are not applicable to repaired tires.

The load carrying capacity of the replacement tire must always equal or exceed the load carrying capacity of the original equipment tire. Tires that are loaded in excess of the allowable maximum load can build up heat and cause sudden air loss.

### LOAD RANGE, INFLATION & SPEED ADJUSTMENTS

Load limits are fundamentally the same for tires manufactured according to American TRA, Korean KS European ETRTO and Japanese JIS standards. Load limits are affected by driving speed, the type of construction of the tire, and the position of the tire (whether it is used in single wheel or dual wheel application).

For recommendations concerning adjustments to driving speed, inflation pressures and load limit increases or decreases refer to the charts below. Also, never exceed the maximum load and inflation recommended by the rim manufacturer.

# Important Safety Warning

## REPLACEMENT TIRES

If mounting tires different from the size originally on the vehicle, consider the following:

### LOAD CAPACITY

Tires must always have equal or greater load carrying capacity than the Original Equipment (OE) tires

### TRANSMISSION RATIO

Tires with a different circumference than OE tires will affect the transmission of power.

- Smaller tires will improve acceleration but reduce top speed
- Bigger tires will reduce acceleration but increase top speed

### RIM DIAMETER

When selecting smaller diameter wheels or rims, check to ensure proper brake drum clearance and sufficient ride height or ground clearance.

### RIM WIDTH

The rim width must always fit in the range specified for the section width of the tire. Usually only small increases or decreases in the tire section width is permissible before requiring a change of rim widths to accommodate any change in tire section width.

### DUAL-WHEEL SPACING

There is a required minimum spacing required between any dual-wheel assembly.

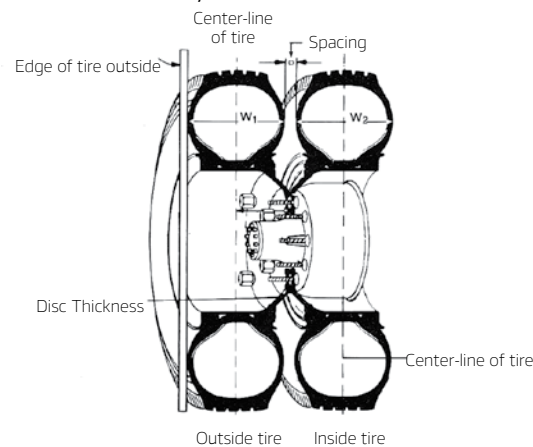

### TIRE SPACING

Spacing between the tire(s) should be checked to ensure adequate clearances.

- To avoid coming in contact with any stationary parts of the vehicle such as chassis, body or undercarriage.
- To avoid hitting or contacting movable suspension parts of the vehicle such as springs or shocks.
- Generally acceptable levels of minimum clearance are 15 mm for fixed parts and 25 mm for movable parts.

**NOTE:** Minimum clearances may change according to vehicle classification.

### TRANSVERSE SPACING

#### 1. Transverse Clearance

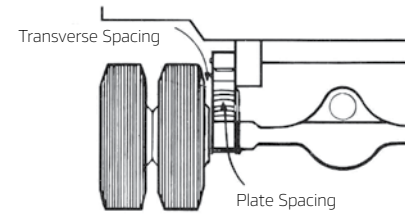

The section width of any replacement tire must also allow sufficient minimum clearance from springs.

#### 2. Vertical Clearance

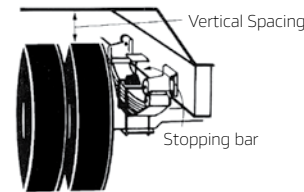

The clearance between the tire and the body and chassis must be checked to ensure sufficient clearance to avoid the tire hitting or scraping against any parts either when the suspension is loaded or unloaded.

The shock absorber and spring ratings stiffness will also affect these clearances. Clearances must be sufficient so that even under maximum suspension travel or deflection, the tires do not contact either the body panels or vehicle undercarriage.

#### 3. Suspension Clearance

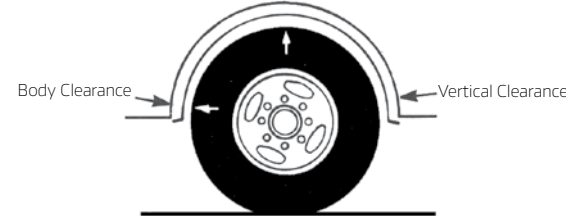

In the case of leaf springs with a swing pivot to allow wheel movement forward and backward, it is important to leave sufficient clearance to allow movement approximately one third that of the distance allowed by the swing action travel.

#### 4. Front-Wheel Clearance

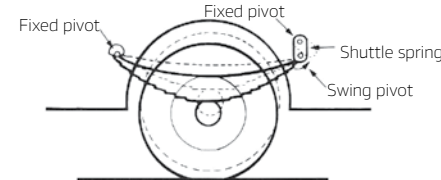

Front-wheel clearance should be checked to ensure sufficient clearance even at lock-to-lock steering positions as well as at the mid-point.

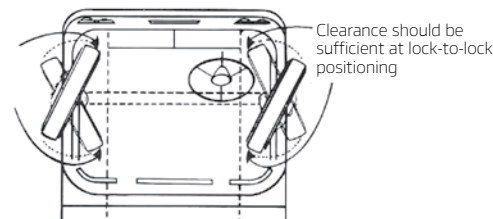

Disregarding any of the safety precautions and instructions contained in this information sheet may result in tire failure or explosion causing serious personal injury or death.

### CLEARANCE CHECKS

Always check to ensure that mounted wheels allow clearance from brake drums/discs, suspension parts or steering assembly, body and other parts. Nothing should be touching either the tire or the valve and there should be a clearance margin of between 20 and 25 mm.

### MATCHING DUAL-WHEEL TIRES

For vehicles using dual wheels it is important that tire circumferences be the same. This is sometimes not the case if tires are not new, of the same tread pattern or have been retreaded. Therefore use a tape measure to match the mounted and inflated tires by circumference prior to installing them on the vehicle.

- Tires must be mounted and inflated to recommended pressures before measuring circumference with a tape measure.
- In situations where they are already mounted as dual-wheels use a square rule to ensure they match in size.
- Ensure uniform sizing on a given dual-wheeled axle by using a long straight rule across the tread of the four tires

## TIRE INFLATION

Measuring Circumference, diameter of dual-wheel tires

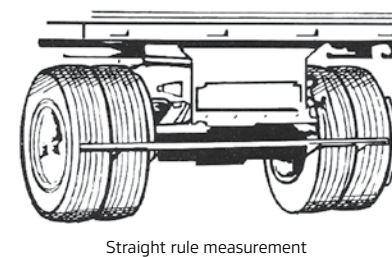
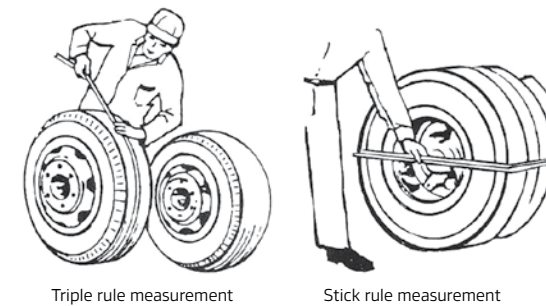

distance). Driving even a moderate distance on tires increases their temperature and the pressure inside, therefore do not decrease the pressure of a "hot" or driven tire as this may result in dangerously inadequate pressure once cooled.

For maximum efficiency it is best to maintain the tires at the recommended inflation and that inflation pressures for both sides should be equal.

It is also advisable to take into account axle load and driving conditions when setting inflations pressures. Compensation for heavier loads can be made by increasing inflation pressures, but do not exceed maximum inflation for the tire or maximum axle load.

Front steering tires may require more inflation when the vehicle is loaded in order to facilitate steering, cornering and wet traction. It is not uncommon that is 20 psi be added in the case of a 11R22.5 14PR tire on the front axle as per the following.

**Example 1** If the load on the front axles is 2,245 kgs then 80 psi would be the normal recommended pressure.

However users frequently apply an added 15 to 20 psi which inflates the tires to 95 to 100 psi to assist steering, load carrying

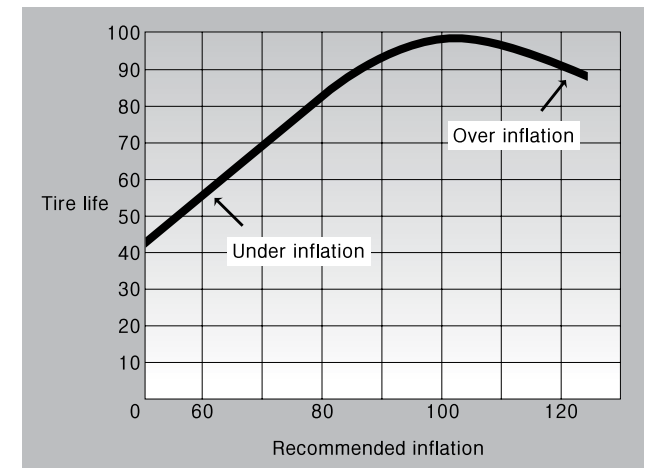

and traction while remaining within specific maximum capacity of 2,920 kgs at max inflation 105psi.

**Example 2** If the front axle load is 2,740 kg, 105psi is recommended. A reduction in speed may be necessary along with slight over inflation (not more than 10%) to compensate for max load conditions. A Hankook Tire serviceman can provide details.

### NOTE:

It is important not to exceed the maximum capacities established by the wheel manufacturers. Wheel product specification should be used in determining any recommendations.

A most important aspect of maintaining tires is proper inflation. Sufficient inflation is needed to carry the load and avoid damage. Driving with proper inflation (particularly grossly under inflated or over inflated tires is dangerous and can cause critical damage or sudden failure of the tire(s).

Proper inflation should be maintained and checked on at least a weekly basis and before long distance drives. Pressures should be checked and adjusted if necessary while the tires are cold (before they have been driven on any significant

## Important Safety Warning

### OVER INFLATED - UNDER INFLATED

Maintaining proper air pressure is the single most important thing drivers can do for their tires. In the span of just one month, a tire can lose 10 pounds of air pressure. It is important to check your air pressure regularly, to make sure your tires are neither under-nor over inflated.

Under-inflation is the worst enemy your tire can have. It causes increased treadwear on the outside edges (or shoulders) of the tire. It also generates excessive heat, which reduces tire durability. Finally, it reduces your fuel economy by increasing rolling resistance-soft tires make your vehicle work harder.

Over-inflation is also detrimental to the tire. Too much air pressure causes the center of the tread to bear the majority of the car's weight, which leads to faster deterioration and uneven wear. Any kind of uneven wear will shorten the life span of your tires. To find the proper air pressure for your tires, [look in the vehicles owner's manual, on the driver's side door jamb or in the glove box] and if you buy new tires, be sure to learn the correct pressure from your dealer. Check your pressure at least once a month using a good quality air gauge or stop by your local Hankook dealer and have your pressure checked and corrected.

### CHECKING TIRE PRESSURE

It is important to check your vehicle's tire pressure at least once a month for the following reasons:

- Most tires may naturally lose air over time.
- Tires can lose air suddenly if you drive over a pothole, an object, or if you strike the curb while parking.
- With radial tires, it is usually not possible to determine under-inflation by visual inspection

For convenience, purchase a tire pressure gauge to keep in your vehicle. Gauges can be purchased at tire dealerships, auto supply stores, and other retail outlets. The recommended tire inflation pressure that (vehicle manufacturers provide reflects the proper psi when a tire is cold) The term cold does not relate to the outside temperature. Rather, a cold tire is one that has not been driven on for at least three hours. When you drive, your tires get warmer, causing the air pressure within them to increase. Therefore, to get an accurate tire pressure reading, you must measure tire pressure when the tires are cold or compensate for the extra pressure in warm tires.

### TIRE INSPECTION

It is wise to inspect the condition of the tire whenever you check inflation. Look for any problems with the tire swells, cracks, irregularities, damage or penetration of any kind. Also inspect the wheels, valves, and valve stems for any possible damage. If found, either consult a Hankook Tire serviceman or have it repaired according to recommendations or if damage is too extensive, discard or destroy the damaged tire(s) to avoid danger of accident or injury.

### SAFETY

Damage and rapid wear are frequently caused by driving conditions such as over loading, rapid stops and starting, uneven road surfaces or road debris (rocks, stones, obstacles). Slow careful driving on rough uneven roads will help prevent some of this type of damage. In addition, alignment irregularities may result from the above mentioned conditions and these should be corrected prior to any high speed or long distance driving.

### TREAD DEPTH MEASUREMENT

Wear measurements should be taken at 90 degree intervals around the circumference of the tire. If two or more of the places read less than 2/32<sup>nds</sup> tread deep wear the tire should be replaced. If the wear indicator bars are exposed, the tire should be replaced. It is dangerous to drive with tires that exhibit wear conditions less than the minimum. Some regions and countries have restrictions based on local conditions that require more tread (ie. a 4/32<sup>nds</sup> minimum). Consult local authorities if you are in doubt.

#### Wear measurement

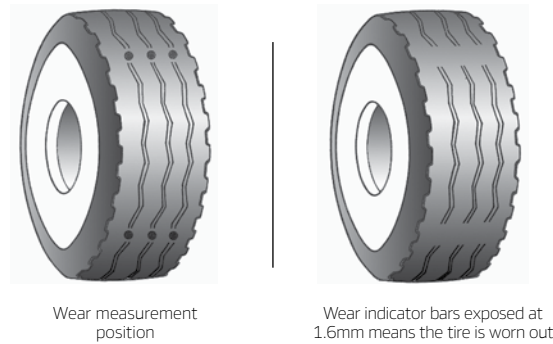

### MAXIMUM LOAD

Do not overload. The loads for truck and bus tires are proportioned to inflation, speed and driving conditions. For safety, follow proper loading, inflation and moderate speeds to suit road conditions. Consult a Hankook Tire serviceman if you are not certain about max load, avoid overloading as it can result in tire damage, broken equipment or injury due to tire failure cause by over heating or excessive load beyond the tire's capabilities.

### PROPER SPEED

Hankook Tire imprints the maximum recommended speed on the sidewall of radial tires in keeping with the industry standards and practices. If a tire is driven more than the max speed specified, it can create high heat within the tire that can result in tire damage or failure. Therefore it is recommended that drivers stay below the tire's recommended max speed and that they do not exceed posted speed limits. It is important that proper tire inflation is maintained at all times, but particularly in the case of highway driving where higher speeds may result in more rapid heat build up in the tire. Also, impacts with road debris and obstacles hitting the tire are more severe and damaging. Reduce speeds to avoid such hazards and to allow time to maneuver around such obstacles.

### TIRE ROTATION

Tires should only be rotated when necessary or when irregular wear is experienced. Vehicle manufacture rotation pattern recommendations should be followed. There is no restriction on cross rotation. Rotating tires to spin in the opposite direction of original position can be beneficial to combat irregularly worn tires. Directional tires should be mounted in the direction of rotation.

Disregarding any of the safety precautions and instructions contained in this information sheet may result in tire failure or explosion causing serious personal injury or death.

### STORAGE

Tires should be stored in a dry, well-ventilated place away from heat, direct sunlight or exposure to fuels, oils, greases or natural gas or electric charges. It is most important to avoid moisture either outside or inside the tire that can cause deterioration of the tire's casing plies which could result in sudden and dangerous failure of the tire.

Cuts or damage to the tire's surface may allow moisture and pollutants access to the tire's casing plies and belts therefore these should be dried, repaired or retreaded prior to storage.

### CHAIN USAGE

Many regions, areas, states or provinces have specific regulations governing the use or restriction of tire chains. In addition you should pay particular attention to the following in situations where use of chains is permitted.

- » Chains must be used only when required by weather conditions. In some cases it is required to install a chain when a warning is issued or an area is posted. Speed must be reduced when using chains. High speed and long distance driving with chains on must be avoided because it can cause serious damage to the tires or failure of the chains.
- » Proper size chains should be used according to the tire size.
- » Proper clearance between the chained wheels and the vehicle are required.
- » The chain manufacturer's information should be followed.

## TRUCK MAINTENANCE

The two major things that affect tire wear are:

- Inflation Pressure
- Vehicle Alignment

### COMPONENTS OF ALIGNMENT

- Toe
- Camber
- Caster
- Ackermann
- Axle Parallelism
  - Thrust Angle
  - Scrub Angle

### TOTAL VEHICLE ALIGNMENT

#### Definition

- The process whereby the vehicle and all the tires are traveling in the same direction .
- Steering axle alone is not sufficient.

### CAMBER

The angle that the center line of the wheel is inclined from the vertical center line perpendicular to a flat road is called camber angle. If the top of the wheel leans out from the perpendicular than it is positive camber. If the top of the wheel leans in from the perpendicular than it is negative camber.

Camber is meant to compensate for the downward forces of the added load. Correct camber settings help the tire maintain firm even tread contact with the tread while the vehicle is traveling under loaded conditions. Often wear at the outside or inside edge of the tire may indicate incorrect camber setting.

- Camber is the inward or outward tilt of the steering axle tires when viewed from the front.
- Positive camber is at the top of the tie tilted out.
- Camber becomes more negative as the load increases.

### TOE

#### POSITIVE NEGATIVE

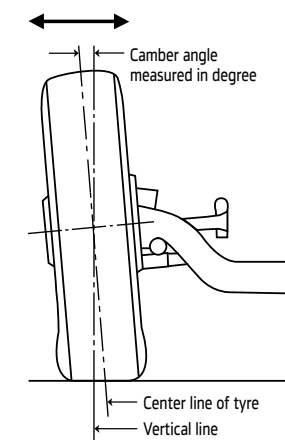

#### Positive camber



#### Negative camber



Toe refers to the inclination of the wheels of the vehicle so that the pair of front wheels (viewing from the front as per the illustration below) is close together at the front than at the rear of the wheels.

The opposite is considered to be toe-out.

The purpose of tie-in is to relieve or counteract some of the force which pulls wheel outward as they roll along the road. Proper toe-in will ensure that the rotation direction of travel are as similar as possible at driving speed.

Insufficient toe-in settings will result in steering instability.

If toe-in or toe-out is insufficient or excessive the tear wear will be effect and appear as feathering at the edges of tread.

- Toe is the inward and outward pointing of the wheels when viewed from the top of the vehicle.
- The goal is to have zero tow when the vehicle is loaded to its normal operating condition.

#### Damage due to contact with the vehicle

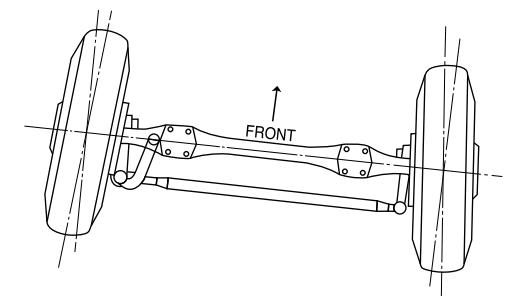

#### Toe-in

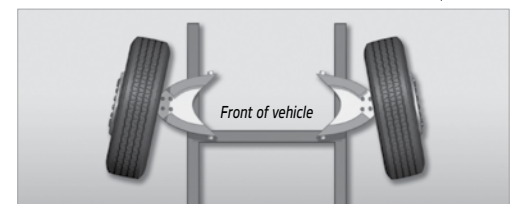

#### Toe-out

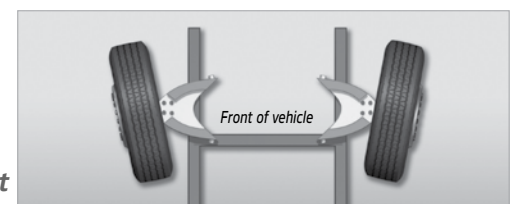

# Important Safety Warning

Disregarding any of the safety precautions and instructions contained in this information sheet may result in tire failure or explosion causing serious personal injury or death.

## CASTER

Caster is the condition where the king pin is inclined with the top of the pin angled rearward similar to front forks of a bicycle. Caster angled is meant to compensate for resistance which the tire(s) encounters as a result of drag forces against the road.

Caster angle should be the same for both wheels on a given axle or the result will be vibration and abnormal wear.

Too much caster will more than compensate for the amount of drag, but will create more difficult steering.

Too little caster and steering becomes light, but unstable and wanders.

Caster angle should be checked as it can be distorted by impacts on the tire or by driving in rough conditions.

- Caster is the forward or rearward tilt of the king pin of the steering axle when viewed from the side.
- Caster is generally not considered to have a great effect on tire wear.

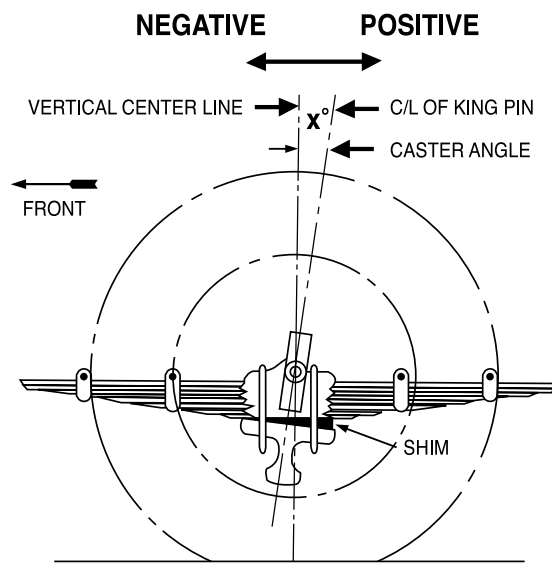

## ACKERMANN

- The Ackerman Principle shows that in any turn the inside tire needs a sharper angle than the outside tire.
- The difference in turn angles between the tires is determined by the actual turn angle at the vehicle wheel base.
- Improper Ackermann causes side force, excessive scuffing, and fast or irregular wear.

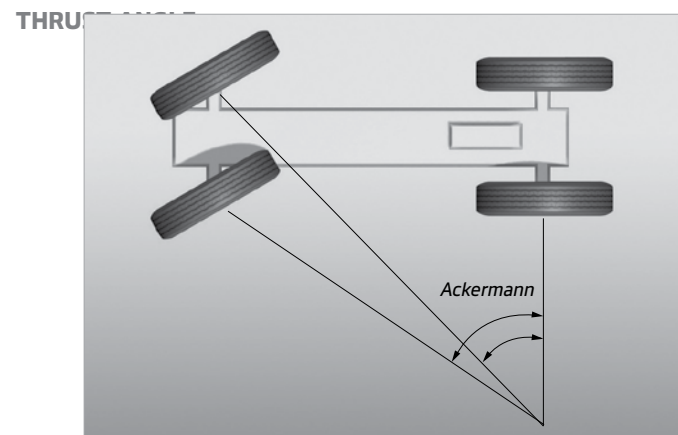

- Thrust angle is the difference between the line perpendicular to the axle and the vehicle centerline.
- Each drive axle has its own thrust angle.
- The target is to have zero thrust angle.

## TANDEM SCRUB

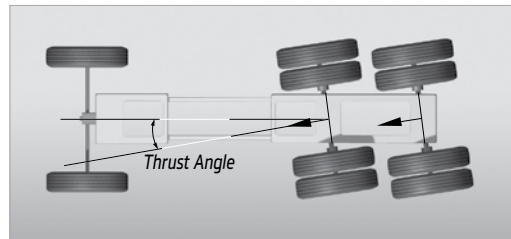

- Tandem scrub is the difference in the thrust angles of the drive axles.
- The target is zero.
- Tandem scrub errors cause constant side force on the steer tires. This leads to irregular wear.

## ABNORMAL TREAD WEAR

Under inflation and over inflation of tires is the prime cause of tread wear. However there are other conditions that influence tread wear and produce irregular patterns of wear.

- Imbalance of tire or tire and wheel assembly.

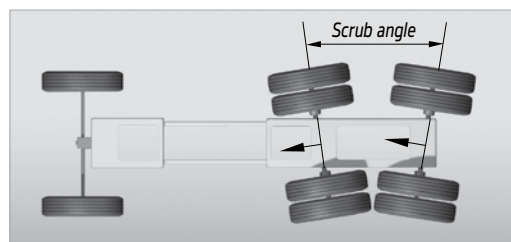

- Improper wheel alignment.
- Braking system problems that may cause wheel lock up or flat spotting.
- Bent round rims.
- Worn or damaged bearings.
- Broken or worn shock absorbers, springs or steering components.

Shoulder wear caused by wrong camber or misalignment

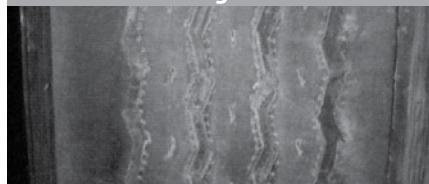

Diagonal Wear

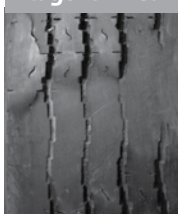

Abnormal Wear



## TIRE DAMAGE

With tubeless tires, it is often possible even with a slow air leak to use the tire carefully enough to get to a service center. Small punctures in the tread area, if detected early enough, can usually be repaired so as to avoid air loss and further problems. However, sufficient loss of air can cause rapid and damaging heat build up within the tire which may result in the failure or separations between the tread and carcass plies. Care should be taken to avoid getting road debris, dirt or moisture penetrating any puncture or trapped inside the tire or between the wheel rim and tire. Damaged tires should always be repaired or replaced at the nearest possible convenience to avoid further tire damage, possible tire failure, vehicle or personal injury.

Check for and correct any of the following conditions:

- Improper tire inflation
- Overloading
- Improper vehicle maintenance
- Brake system abnormalities
- Differences of tires sizes or circumferences on the same axle
- Improper mounting of tire or wheel
- Improper, worn or damaged valve
- Improper use of tube or flap

Burned Beads

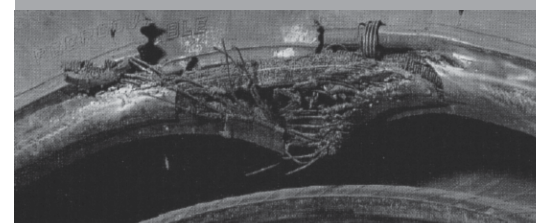

Ripped Sidewalls

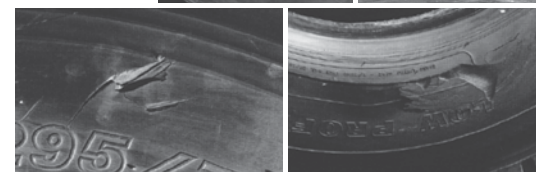
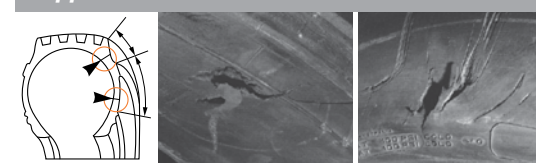

Sidewall damage due to run flat or severe under inflation

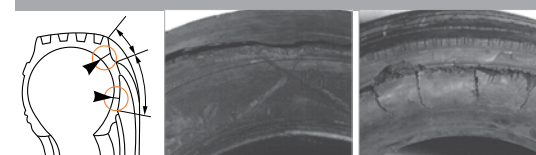

Damage due to contact with the vehicle



Flat spotting due to locked brakes

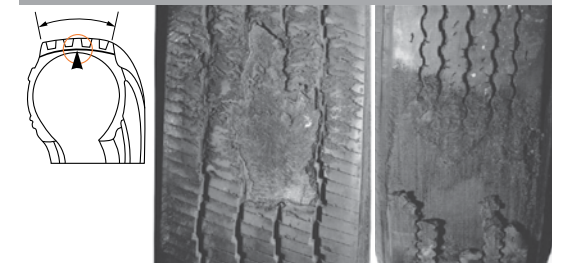

Bead damage due to curbing

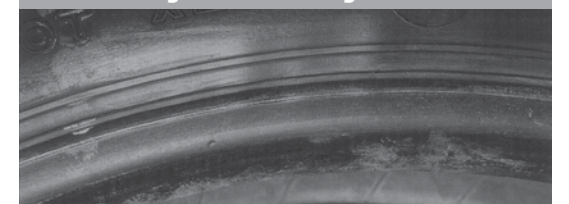

## HEAT CAN DAMAGE TIRES

Under inflation, overloading, or excessive speed can cause damage because of heat build up. Tire parts such as cord, the bonding between carcass, belts, and treads can be easily damaged by excessive heat. Most tire cords lose strength at temperatures above 120° C making the tire more vulnerable to failure. Excessive heat can weaken or damage cords or rubber compounds or cause separation between the plies.

## MOISTURE DAMAGE

Moisture inside the tire or penetrating through to the steel belts of a radial tire can cause rust damage to the steel cord or the rim.

Therefore always:

1. Store tires indoors in a dry place.
2. Ensure wheels, flaps, tubes, valves, and the inner tire surface are clean and dry before and during mounting.
3. Use the recommended mounting lubricant on the rim and tire bead during the mounting process.
4. Maintain inflation and keep the valve stem capped or protected so as not to allow moisture to enter the tire.

## PREVENTING TIRE DAMAGE

- Proceed with caution if you have to go over a pothole or other object in the road.
- Do not run over curbs or other foreign objects in the roadway and try not to strike the curb when parking.

# Important Safety Warning

## TIRE SAFETY CHECKLIST

Check the tire pressure regularly (at least once a month), including the spare.

- Inspect tires for uneven wear patterns on the tread, cracks, foreign objects, or other signs of wear or trauma.
- Remove bits of glass and other foreign objects wedged in the tread.
- Make sure your tire valves have valves caps.
- Check tire pressure before going on a road trip.
- Do not overload your vehicle. Check the tire information placard or owner's manual for the maximum recommended load for the vehicle. If you are towing a trailer, remember that some of the weight of the loaded trailer is transferred to the towing vehicle.

## MOUNTING & DEMOUNTING

### SAFETY INSTRUCTIONS

Do not mount or demount tires without proper training. Wall charts containing mounting and demounting instructions for all highway rims should be available through your normal rim supplier.

#### Remove all cracked wheels from service

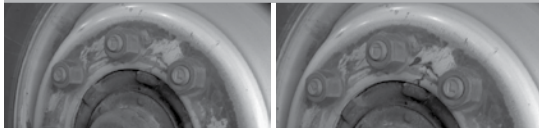

#### Lubricate areas shown by arrows

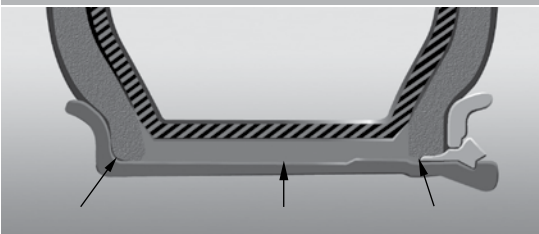

#### Use of GG ring to indicate correct mounting



#### Proper sequence for tightening stud nuts on an 8 stud system



**Note:** Always use a securely held safety cage and extension hose with clip on air chuck for airing the tire. Rapid air loss can propel the assembly.

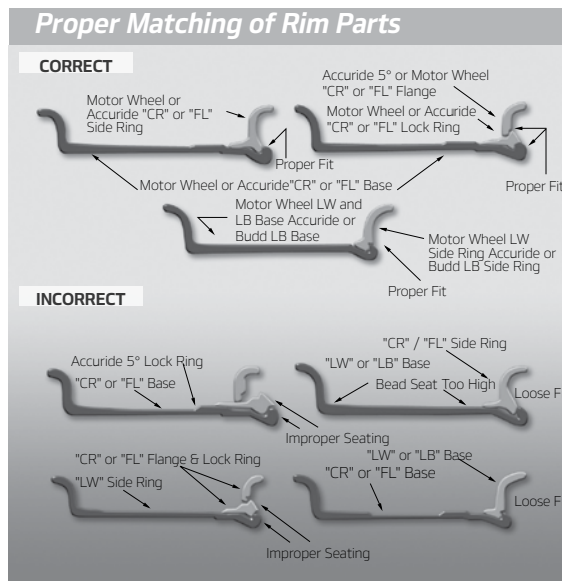
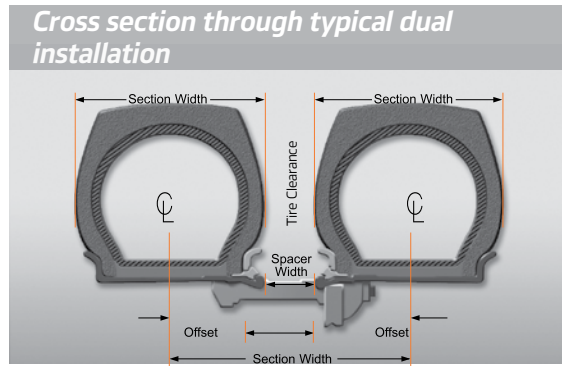

### TUBE-TYPE TIRE MOUNTING

All parts should be clean and free of water or foreign matter. A new tube should be used, because reused or old tubes stretch or increase in size which can lead to problems with the tube folding, cracking or wearing too rapidly. Proper sized radial tubes should be used in radial tires. Radial tubes are designed to handle the radial profiles and flexing requirements.

### WHEEL PREPARATION

For safety reasons check the following in regards to mounting and demounting tires and wheels.

- Rim diameter, rim width and flange design must be that recommended for the tire
- Rim profile must be appropriate to the type of tire (tube-type or tubeless) that is being used.
- The angle and position of the tire bead must seat properly to the rim.

Before mounting, the wheel should be inspected for any cracks, breaks, damage, misplaced parts or deformities or irregularities at the locking ring rim flange, surfaces or valve hole. Any signs of weak welds, dents, rough surfaces or dust should be corrected or a new of more suitable wheel should be used. If corroded, clean the rim with a wire brush, sand it smooth and paint it with anti-rust paint. Any dents and rough surfaces must be smoothed.

**Note:** Be careful to demount the tire prior to attempting any wheel repair such as hammering, heating or welding of wheels.

Disregarding any of the safety precautions and instructions contained in this information sheet may result in tire failure or explosion causing serious personal injury or death.

### PROPER MOUNTING AND DEMOUNTING

Follow all mounting and demounting procedures and equipment safety cautions. Always keep tools and work areas clean and free of oil and grease.

**Note:** Tire mounting lubricant is necessary for mounting and demounting tires.

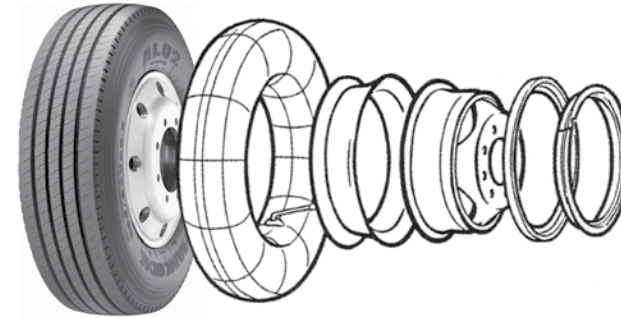

**Note:** Use of any improper design, size or type of tube may cause tube breakage or damage to your Hankook radial tire.

Confirm that the tube is the proper type and size with the correct valve stem type suitably fit the wheel hub and clearances for brake sand wheel parts. The valve stem should screw into the tube with a rubber bushing or washer. This should be a secure, clean attachment to the tube.



### VALVE STEM ATTACHMENT

Do not screw the valve stem in the wrong direct or beyond the recommended tightness.

The step by-step mounting procedure should be followed: Insert the new tube in the dry clean tire and inflate it slightly, just until the tire becomes round. The proper sized new flap should be used. Definitely do not use used flaps that are brittle, cracked, broken or stretched.

### TUBE-TYPE TIRE MOUNTING

Mount the flap inside the tire being careful not to buckle the flap edges over and under. Center the flap and position it so that the valve hole lines up. Inflate little more so that flap is held close between tire and tube. It will not conform perfectly in shape until later.

- After lubricating the rim flange, tire bead and flap where it will touch the rim.
- Slide the tire/tube/flap assembly onto the rim
- Combining the side ring and lightly rap the locking ring into proper position. Do not use excessive hammering and avoid hitting the tire.

### SAFETY CAUTION

Use an accurate air gauge and an air line and a remote operating nozzle long enough to allow you a distance of personal safety from the tire assembly for the remainder of the inflation process.

**Note:** Do not stand in front of any wheel while inflating the tire.

- Inflate slightly and recheck to ensure the assembled parts are in proper position. Inflate slightly more and check to ensure tire bead has seated (slide over to make complete contact with the rim flange). If not, deflate, lubricate and re-try assembly.
- Release any air trapped between the tube, flap and tire by deflating and then reinflate to get proper conforming fit of the flap.

### SETTING FINAL INFLATION PRESSURE

Install a new valve core each tire a new tire is mounted. Use a tire safety cage and a remote operating air nozzle. Re-check that the assembly is going together properly at every stage of the process.

Inflate in stages, re-checking that the assembly is going together properly at every stage until the recommended inflating pressure is reached. Then add a valve cap after adjusting to the final recommended pressure.

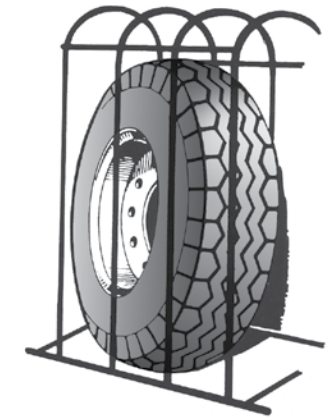

### SAFETY CAGE

**Note:**

- Use the safety devices at all times. Do not stand in front of the tire or the valve during inflation.
- Before final inflation, check the assembly condition carefully.
- Check if there is any leakage.
- Use only the correct, clean mounting and demounting levers, paying attention that they are not oily or greasy which could cause them to slip.
- Use only the recommended equipment and do not apply excessive force or hammering.

Tire should be deflated before dismounting the wheel assembly from the vehicle. Clear away any foreign matter from the valve stem and area, prior to releasing the valve stem to let the air escape.

### DEMOUNTING THREE-PIECE WHEEL ASSEMBLIES

Place the wheel assembly on firm clean ground or floor with the lock-ring side facing upward. Then use the tire demounting lever with a spoon-type tip to pry between the rim flange and the tire bead. Work around the tire operating the lever between the bead and the rim flange. Avoid operating on the same place several times. After the bead and rim separate, put the lever in the groove at the base, separate the lock-ring and remove the side ring.

# Important Safety Warning

Disregarding any of the safety precautions and instructions contained in this information sheet may result in tire failure or explosion causing serious personal injury or death.

## Base Part of Tubeless Rim

The Tubeless tire rim Parts marked "///" are to be cleaned and lubricated.

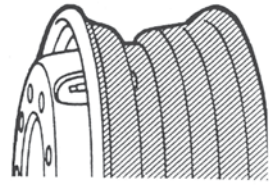

## TUBELESS TIRE MOUNTING

### RIM PREPARATION

- Rim must not be broken or damaged.
- Remove the rubber bushing from the valve stem hole. Inspect the valve stem for any signs of damage or wear.
- Remove rust, dirt and any foreign materials from the rim. Clean and sand smooth the area marked "///" in the above picture. If rusted, clean and repaint the rim surface to protect it from rusting.
- If required, replace any worn or damaged valve stem.
- Lubricate the inner parts of the rim surface where the tire mounts (marked "///")

### TIRE PREPARATION

In the case of new tires, wipe the bead clean with a dry cloth and verify that it is not damaged, kinked, or broken. Apply the recommended lubricant to the tire bead as per the following illustration.

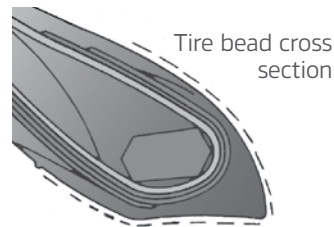

### INSIDE BEAD ASSEMBLY

Lay the wheel on a clean flat surface with the valve facing upward. Work the bead over the rim flange, using your hands and knees as in the illustration below. If it is difficult to fit over the flange, use the proper tire mounting lever as per the illustration.

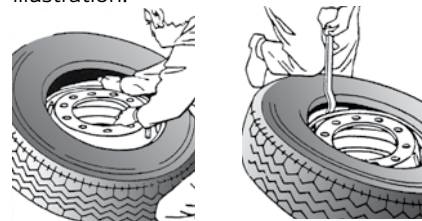

### OUTSIDE BEAD ASSEMBLY

Start the outside bead placement over the outside rim flange by hand. Begin at the point where the valve stem is located. Once hand placement become difficult, use the proper tubeless tire bead mounting lever to complete the job as per the following illustrations. When mounting tires, do not use excessive force and avoid heavy tools or impacts such as hammering on the rim.

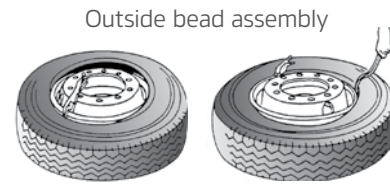

## TUBELESS TIRE INFLATION

Use an inflation gauge, suitable remote air hose nozzle, and a safety cage when inflating the new mounting tire. The lubricated bead should seat firmly to the rim flange at about 10 PSI inflation. Do not stand near or in front of tire while inflating. Use the safety cage and a safe distance for your protection. If the bead fails to seat first try, then rotate the tire a few degrees around the rim, ensure the rim and bead flange is lubricated and try again. If for any reason the bead does not appear snugly and evenly seated, do not attempt to inflate further. Repeat the entire assembly process with perhaps more lubricant on the bead and rim areas.

Once the bead seats the bead and rim flange are a snug even fit all the way around. Then inflate the tire to the recommended inflation pressure to the axle load. Check that the tire or valves are not leaking and tighten on a valve cap.

## TUBELESS TIRE DEMOUNTING

The tire should be completely deflated before demounting. This is done by loosening and removing the valve stem core, being careful that there is no foreign matter left in the valve and that the valve stem is not cracked or damaged. Do not stand near the valve stem during the deflation process.

### BEAD DEMOUNTING

Place the tire assembly on a clean flat surface with the valve facing upward. Use a tire demounting lever

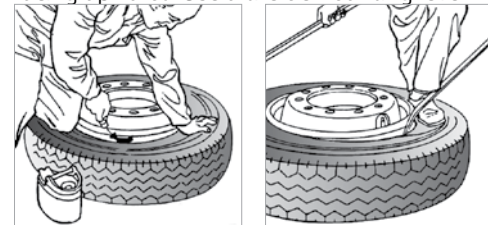

### OUTSIDE BEAD DEMOUNTING

Use the tire demounting lever to pry the bead over the rim flange directly in line with the valve stem as per the following illustrations. A second lever is used about 30cm around the rim from the first to pry the bead over the flange. Repeat the process around the tire until the outside bead is fully demounted.

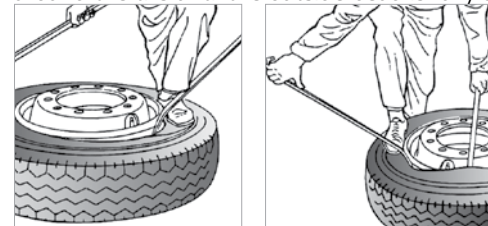

### INSIDE BEAD DEMOUNTING

Turn the tire assembly over. Lubricate between the bead and the rim then insert the tip of the tire lever between the tire and rim and apply pressure. Use the second lever about 15 cm around the edge of the rim. Repeat the order until the bead is completely demounted.

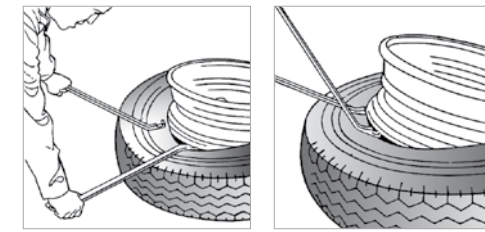

## TUBELESS RIM VALVE MOUNTING

### A-TYPE RIM VALVE

The valve hole in the rim must be clean, smooth and not damaged. Apply a recommended lubricant to the rubber bushing of the valve. Insert the valve stem through the rim hole, assembling the washer and lock-nut on the inside and tighten the lock-nut with a wrench so that the valve stem is secured to the rim.

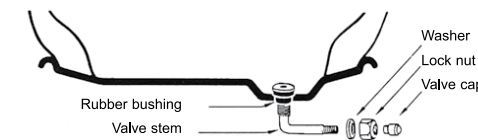

### B-TYPE RIM VALVE

The valve hole in the rim must be clean and not damaged. As per the illustration below place a lubricated O-ring on the valve stem, insert the stem into the valve stem hole in the rim so that the valve stem faces perpendicular to the rim. Then tighten the lock nut with a wrench from the opposite side of the rim until the valve stem is secure.

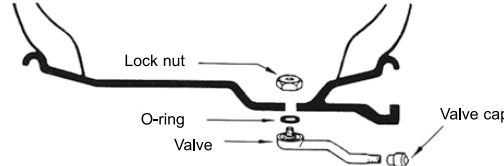

### C-TYPE RIM VALVE

The valve hole in the rim must be clean, smooth and not damaged. As per the illustration below, lubricate the O-ring and insert a new valve stem through the O-ring and then through the valve stem hole in the rim from the inside. From the other side, securely hand tighten on the lock nut.

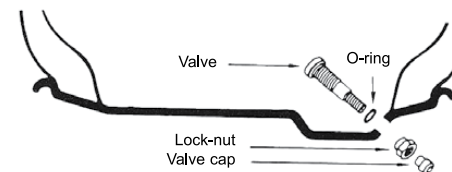

## TIRE REPAIRS

Tire repairs normally made by fleet operators and tire service centers are limited to simple punctures such as nail holes. Anything more extensive, such as spot, reinforcement, or section repairs should be referred to an authorized HANKOOK retreading and repair facility. Significant cuts and cracks in the sidewall area should be spot repaired as soon as possible to prevent the need for a major section repair.

Frequent tire inspection in service is recommended. This section gives information concerning tire damage, extent, and location, to help determine whether or not section repairs are feasible.

## NAIL HOLE REPAIR PROCEDURES

Radial nail hole repairs up to 3/8-inch diameter (9.5 MM) may be in the tread face as long as the nail hole is at least one-inch inside the shoulder. All injuries outside this point should be treated as a section repair.

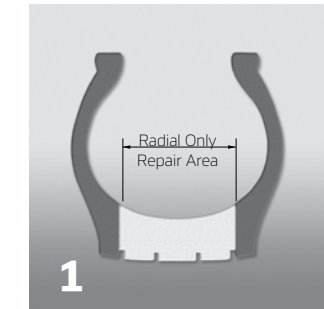

Any number of repairs in the crown area only (use outer grooves as a guide). Refer larger injuries to a full service repair shop. Do not overlap patches.

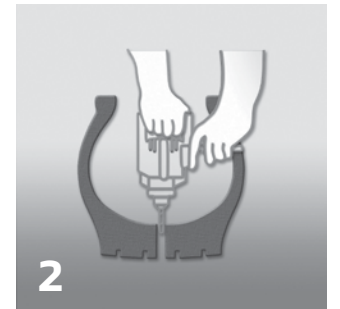

Beads in relaxed position. Using a tapered drill bit/carbide cutter, drill a hole from the inside. Using a proper reamer, lubricate the hole with chemical cement.



Brush chemical cure cement on nozzle and insert into the hole while turning clockwise.



Cut excess plug 1/16" high on inside. Do not stretch plug.

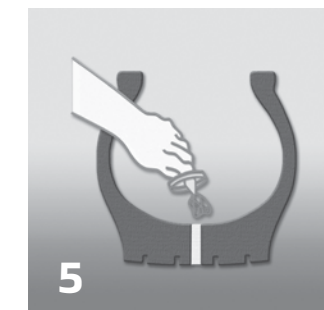

Apply brush type Nylonbond cement to the buffed surface only and allow to dry thoroughly when using "versacure" patches with heat applied. When heat is not applied, use chemical vulcanizing solution, applied to the buffed liner surface only.



Beads in relaxed position. Remove backing from specified "versacure" patch. Center the patch over the plug and stitch the patch from the center out. Arrows on the patch must point toward the tire bead.

## SECTION REPAIR LIMITS IN SIDEWALL & SHOULDER AREA

Most sidewall injuries will be split-type, caused by snags and punctures. Maximum injury sizes for sidewall and shoulder repairs are shown below.

The number of these section repairs should be limited to 2 per tire for line haul service and 3 for city service, no closer than 1/4 of tire circumference apart.

Spot repairs may be made without limit proving that the body plies are not exposed or damaged. Existing repairs must be reworked if loose or questionable.



# Limited Warranty

Disregarding any of the safety precautions and instructions contained in this information sheet may result in tire failure or explosion causing serious personal injury or death.

## WARRANTY TERMS

This limited warranty applies to the original purchaser of any new truck and bus tire manufactured by Hankook Tire and Technology bearing Department of Transportation prescribed tire identification numbers. Eligible tires shall be used on the vehicle on which they were originally installed according to the vehicle manufacturer's or Hankook's recommendation. This warranty applies if all following qualification requirements are met:

1. The tire was purchased after January 1, 2024.
2. The tire is a size, load rating and speed rating equal to or greater than that recommended by the vehicle manufacturer.
3. The tire has not become unserviceable due to a condition listed under WHAT IS NOT COVERED

## WHAT IS WARRANTED AND FOR HOW LONG

Should any tire covered by this limited warranty become unusable due to a workmanship or material related condition during its usable tread life (more than 2/32nds remaining tread), Hankook will give a credit on the following conditions:

1. During the first 2/32nds of the original usable tread and within one year: Tire will be replaced with a comparable new Hankook produced tire free of charge. Applicable taxes on the new tire and cost of mounting, balancing and any other charges in connection with the replacement of the tire are required to be paid by the owner.
2. After the first 2/32nds of the original usable tread or after one year from date of purchase, whichever occurs first: The amount of the credit will be determined by multiplying the Dealer's current selling price for the same tire (excluding taxes) by the percentage of tread remaining, based on the original tread depth.
3. Free replacement workmanship warranty is not applicable to snow tires.

## WHAT IS NOT COVERED

This limited warranty does not apply to tires which are being serviced under the following conditions:

- » Originally purchased outside of the United States or Puerto Rico.
- » Willful Abuse / Collision / Wreck / Fire.
- » Continued use while flat or severe under/over inflation.
- » Road Hazards including (without limitation), puncture, cut, impact break, stone drill, bruise, bulge, snag, collision.
- » Premature/irregular wear from (without limitation): vehicle mechanical reason, and/or improper maintenance.
- » Conditions resulting from (without limitation), improper mounting/demounting, under inflation, improper tire size, improper repair, defect in vehicle, abuse.
- » Ride disturbance complaints after 2/32nds tread wear or 1 year from date of purchase, whichever occurs first.
- » With 2/32nds or less of remaining tread depth.
- » With the serial/DOT number cut or buffed.
- » Racing and Misapplication.
- » Tires 6 years or older from the date of manufacture or 6 years or older from the date of purchase.
- » Loss of time or use, inconvenience or any incidental or consequential damage.
- » Tires worn beyond original full tread depth will not have FET reimbursed.

- » Tires with minor cosmetic weather/ozone cracking.
- » Ozone or weather cracking on tires over four (4) years old from the date of manufacture.
- » Note: Consequential damage mentioned above may not apply to you based on States limitation.

## OWNER'S GENERAL OBLIGATION

In order to be eligible for HANKOOK's limited warranty program, the owner must observe the following:

- » Present the tire to an authorized Hankook dealer in the United States of America or Puerto Rico.
- » Submit or present a copy of the original purchase receipt.
- » Sign a completed Hankook Claim Form filled by any authorized dealer.
- » If the tire owner abuses the tires and/or fails to do the following (but not limited to): observing safety warnings, maintaining proper inflation pressure, maintain vehicle alignment, expected tire performance and/or life may not be achieved and safety cannot be ensured.
- » Tires presented for a warranty claim remain the property of the consumer, and Hankook bears no responsibility for lost or damaged tires which are in the possession or control of any dealer. Should a claim be disputed, the consumer must make the tire available for further inspection.

## RETREAD ALLOWANCE

Tread Depth Remaining (Inches)	Total Allowance Retreaded Tires (Retread Allowance + Casing Allowance)
More than 14/32	\$45.00 + Casing Allowance
8/32 to 14/32	\$30.00 + Casing Allowance
Less than 8/32	Casing Allowance Only

- » For 19.5 inches or smaller sizes, only casing allowances warranted.
- » Tires used in mining and logging service are not covered under this warranty.

## CASING WARRANTY

1. Casing of Hankook steel radial truck & bus tires are warranted when tire becomes unserviceable or unretreadable due to factors within manufacturer's condition, Hankook will provide predetermined casing allowance.
2. Casing warranty is valid through the 2nd retreaded life for six (6) years from the date of manufacture. (AL52, AL21, AL50, DL15+, DL21, TL21, DL52 casing warranty is valid through unlimited retreads for seven (7) years from the date of manufacture).
3. e<sup>3</sup> Wide (DL07, TL07, TL21, DL12, DL21) casing warranty valid through the 3<sup>rd</sup> retread for six (6) years from date of manufacture.
4. Tires used in mining & logging service are not covered under this warranty.
5. Casing & retreading allowance in the following section.

## CASING ALLOWANCE

Category	Size	No of Retread				Remark
		Never	1st	2nd	3rd	
Premium Pattern :	295/60R22.5 295/75R22.5 285/75R24.5 11R22.5 11R24.5	\$130	\$110	\$90	\$70	Casing value will be same after 3rd times retread
e <sup>3</sup> Wide Pattern:	445/50R22.5	\$150	\$120	\$90	\$70	
Normal	11R22.5 11R24.5 255/70R22.5 275/70R22.5 295/75R22.5 305/70R22.5	\$110	\$90	\$70	-	
	315/80R22.5 285/75R24.5 385/65R22.5 425/65R22.5 445/65R22.5					
Normal	9.00R20 10.00R20 11.00R20 12.00R20	\$90	\$80	\$70	-	
	12.00R20					
	215/75R22.5 235/75R22.5 8R19.5					

## DISCLAIMER

THIS WARRANTY IS MADE IN LIEU OF ALL OTHER WARRANTIES, EXPRESS OR IMPLIED, AND HANKOOK EXPRESSLY DISCLAIMS ALL IMPLIED WARRANTIES OF MERCHANTABILITY OR FITNESS FOR A PARTICULAR PURPOSE. SOME U.S. STATES AND/OR CANADIAN PROVINCES DO NOT ALLOW LIMITATIONS IN THE DURATION OF AN IMPLIED WARRANTY, SO THE ABOVE MAY NOT APPLY TO YOU.

TO THE EXTENT PERMITTED BY LAW, HANKOOK DISCLAIMS LIABILITY FOR ALL CONSEQUENTIAL AND INCIDENTAL DAMAGES.

THE REMEDIES SET FORTH IN THIS LIMITED WARRANTY ARE THE SOLE AND EXCLUSIVE REMEDIES FOR BREACH OF WARRANTY.

Some U.S. States and/or Canadian provinces do not allow the exclusion or limitation of incidental or consequential damages, so the above limitation or exclusion may not apply to you. This Limited Warranty gives you specific legal rights, and you may also have other rights which vary from U.S. State or Canadian province to province.

• THIS IS THE ONLY EXPRESS WARRANTY MADE BY HANKOOK. NO HANKOOK EMPLOYEE, RETAILER, OR DEALER HAS THE AUTHORITY TO MAKE ANY WARRANTY, REPRESENTATION, PROMISE OR AGREEMENT ON BEHALF OF HANKOOK EXCEPT AS EXPRESSLY WRITTEN IN THIS TOTAL WARRANTY. IN OBSERVANCE OF U.S. FEDERAL LAW, THIS WARRANTY HAS BEEN DESIGNATED A "LIMITED WARRANTY."

## ADDITIONAL INFORMATION OR CUSTOMER SERVICE

If you have any question on product warranty, please first contact your nearest Hankook Tire Dealer. For dealer information, or if your question has not been handled to your satisfaction, contact the Hankook Tire Technical Department.

HANKOOK TIRE AMERICA CORPORATION  
1-800-HANKOOK  
333 Commerce St. Suite 600 Nashville, TN 37201

For warranty information, please visit

[hankooktire.com/us](http://hankooktire.com/us) or call 1-800-HANKOOK, option 1 for Technical Dept.

## Claim Adjustment Procedure

For all claims for adjustment, a claim form must be filled out. Adjustment claims can be completed online at ( [eorder.hankooktire.com/](http://eorder.hankooktire.com/) ) by logging in and accessing the "Warranty Return" section. Completed claim form shall be mailed to Hankook Tire America Corp. office. Do not ship tires to Hankook unless requested to OR you meet the minimum requirements of Hankook's TBR tire shipping policy (page 21). Hankook reserves the right to demand physical inspection of the tires on which adjustment is claimed.

### A. If the examination shows that the tire is adjustable under the terms of our Warranty

1. Be sure that the tire returned by the consumer bears our name and DOT number.
2. Measure the remaining tread depth in 32nds of an inch. Be sure to measure in grooves nearest the center line of the tire.
3. Refer to ORIGINAL TREAD DEPTH for the size and type of the returned tire. Use the ORIGINAL TREAD DEPTH CHART to determine the percentage of credit due based on remaining tread depth.
4. Fill out the HANKOOK TIRE CLAIM FORM completely (can be filled online), sign it yourself and have it signed by the owner of the tire.

### B. Fill out each claim form with the following information for each tire being adjusted

Adjustment claims can be completed online at ( [eorder.hankooktire.com/](http://eorder.hankooktire.com/) ) by logging in and accessing the "Warranty Return" section. For hand written claims, see example shown on page 19. This form must be accurately completed by the dealer and signed by the owner of the product. Incomplete forms will not be accepted.

### C. Marking tires for physical inspection

For accumulation of 6 tires or greater, follow Hankook's shipping policy (page 21). Please mark all tires being shipped to our claim center in the following manner.

1. Clearly state dealer's name.
2. Mark over identification (DOT) number with crayon and make clearly legible (Disregard if DOT has been cut & sent in with claim).
3. Tire condition - Circle the area showing the claimed condition with a tire crayon. Out of Round/Ride Disturbance claims should be marked with "OOR".
4. Write claim number close to DOT number using the last 4 digits of the claim number, plus the line number from the form. Example: claim number is H5009876, and claimed tire is from line 3 of the form, then write "9876-3" near the DOT number
5. Attach a copy of all claim forms and any supporting documents (purchase record, install record, maintenance docs, etc.) to one of the tires, or give to carrier driver.

### D. For photo inspection

Accumulation of 5 tires or less: Complete Hankook Claim Form, with dealer point of contact information, and send relevant invoices/ documents and also photographs of the condition(s) being claimed. Upon receipt, Hankook will review and approve or reject the claim. Upon notification of approval, DOT will need to be skived from the tire(s) and mailed with reference to the corresponding claim form number (ex. H1234567) within 28 days from notice of approval.

### E. Forwarding claim forms to Hankook

Retain "Dealer's Copy" and retain copies of any other supporting documents and/or photos for dealer records, and forward all other copies to: Hankook Tire America Corp.  
Attn: Technical Department  
333 Commerce Street Suite 600  
Nashville, TN 37201

### When an adjustment is received, Hankook will...

Review the claim and either issue credit or request the tires to be shipped to our claim center for physical inspection. If we decide a physical inspection is necessary, we will send you a written request to ship the tires to a designated location.

**NOTE:** DO NOT send tires to our claim centers unless you are requested to do so OR you meet the minimum requirements of Hankook's TBR tire shipping policy (page 21).

Tires must be held by you for thirty days or until credit or further notice has been received, whichever is later. If tires are requested to be shipped for inspection during this period and are not available, claim will be disallowed and adjustment credit will not be issued.

If Hankook exercises its right to inspect, it will do so by sending a written request to ship the tires to Hankook's Claim Center. In determining the cause for removal from service, always examine both the inside and outside of the tire body. If the tire is not entitled to adjustment, Hankook will advise the dealer; explain the reason for the failure and advise him/her of preventive maintenance.

### Remember :

1. Adjustments will be made on a pro-rata basis, calculated on remaining usable tread depth and the Dealer's current selling price of the same tire, if there is no applicable special warranty program.
2. Usable tread depth is the original depth less 2/32nds of an inch.
3. When the tire is worn down to 2/32nds or less, the tire is considered worn out and the limited warranty expires.
4. For photo inspection on tires still usable/retreadable, do not skive and mail DOT until adjustment is approved by Hankook Technical Department.
5. The result of physical inspections by Hankook will prevail over your findings to the contrary subject to your right to legally contest our findings.
6. Where physical inspection is required, please refer to page 17, section "E. Marking tires for physical inspection" and page 21 "Freight Policy" for tire marking and shipping instruction.

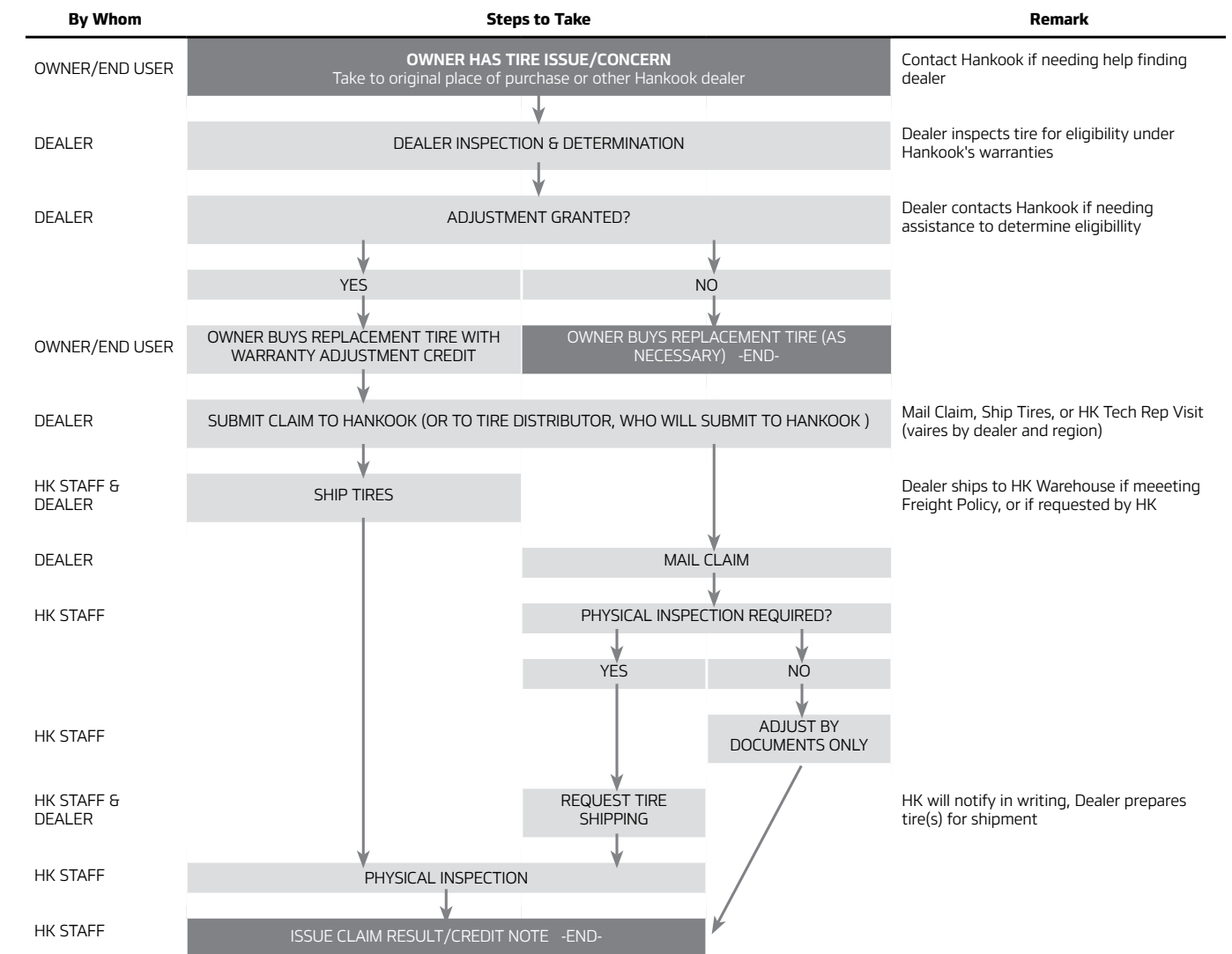

Paper Form

**HANKOOK** TIRE WARRANTY CLAIM FORM H  
*driving emotion*

HANKOOK TIRE AMERICA CORP. Technical Department  
333 Commerce Street, Suite 600  
Nashville, TN 37201  
Tel: 1-800-HANKOOK (426-5665), opt 1

THIS FORM MUST BE ACCURATELY COMPLETED BY THE DEALER AND SIGNED BY OWNER USING THE PRODUCT. INCOMPLETE FORMS WILL NOT BE ACCEPTED.

**1** DATE OF CLAIM

**2** DISTRIBUTOR    **3** DEALER    **4** FLEET (Commercial Use Only)    **5** OWNER-USER

NAME: ADDRESS: PHONE NUMBER: ACCT#

**6** POINT OF CONTACT FOR CLAIM SUBMISSION

NAME: **7** YEAR    **8** MAKE    **9** MODEL    **10** VIN NUMBER

PHONE: VEHICLE USAGE (NORMAL / COMMERCIAL / OFFROAD / RACING / ETC) **11** ORIGINAL EQUIPMENT **12** Yes No    IF "YES", DATE VEHICLE PURCHASED **13**

EMAIL: INSTALL DATE **14** INSTALL MILES **15** REMOVAL DATE **16** REMOVAL MILES **17** TOTAL MILE **18** STAGGERED FITMENT **19** Yes No

ITEM NO.	SIZE / PLY	PATTERN	PART / MATERIAL NO.	HTAC USE ONLY	D.O.T. NUMBER	BARCODE (LOCATED ON BEAD)	REM. TREAD DEPTH	HTAC RSD	TIRE MILES	TIRE POSITION (LF, RF, LR, RR)	CLAIM REASON	# OF RETREADS
1.	<b>20</b>	<b>21</b>	<b>22</b>		<b>23</b>	<b>24</b>	<b>25</b> /32		<b>26</b>	<b>27</b>	<b>28</b>	<b>29</b>
2.							/32					
3.							/32					
4.							/32					
5.							/32					
6.							/32					

**30** NOTICE TO OWNERS FREIGHTING TIRES: If claim is disallowed, the product will be scrapped unless the box below is checked:  
 RETURN FREIGHT COLLECT ("POINT OF CONTACT FOR CLAIM SUBMISSION" field must be completed)

**31** If claiming for 30 Day Trial, please indicate return reason(s):  
Please check all that apply:  
 Vibration     Wet Traction     Tracking/Pulling/Wandering  
 Handling     Snow Traction     Braking  
 Noise     Dry Traction     Other: \_\_\_\_\_  
 Efficiency     Appearance \_\_\_\_\_

Additional Notes:

I hereby certify that to the best of my knowledge the foregoing statements are correct, and that I am convinced the product presented for adjustment was not involved in a motor vehicle accident. Dealer's Signature **32**

I hereby certify that to the best of my knowledge the foregoing statements are correct, that I am the original owner-user of the product presented for claim, and that the product described was not involved in any accident, personal injury, consequential damage, or other loss. I accept the adjustment in lieu of all further claims. I understand that the tire(s) detailed on this claim become the property of Hankook Tire America Corp. Owner-User's Signature **33**

**HTAC USE ONLY**  
Date Received: Initials:  
V: V: \_\_\_\_\_  
W: W: \_\_\_\_\_  
O: O: \_\_\_\_\_

**TIRES MUST BE HELD UNTIL FURTHER NOTICE, OR UNTIL CREDIT IS RECEIVED. SHOULD TIRES BE REQUESTED FOR INSPECTION AND BE UNAVAILABLE, ADJUSTMENTS CREDIT WILL NOT BE ISSUED.**

**PLEASE SEE REVERSE SIDE FOR COMPLETE INSTRUCTIONS FOR SUBMITTING CLAIM.**

**NOTE : Please completely fill in the following items:**

- |  |                        |                            |
|--|------------------------|----------------------------|
| 1. Date of Claim                           | 12. Original Equipment | 24. Barcode                |
| 2. Distributor/Wholesaler Info             | 13. Date Purchased     | 25. Remaining Tread Depth  |
| 3. Dealer/Retailer Info                    | 14. Install Date       | 26. Tire Miles             |
| 4. Fleet Info                              | 15. Install Miles      | 27. Tire Position          |
| 5. Owner-User Info (End User)              | 16. Removal Date       | 28. Claim Reason           |
| 6. Contact Info for Person Preparing Claim | 17. Removal Miles      | 29. Number of Treads       |
| 7. Vehicle Year                            | 18. Total Miles        | 30. Return Freight Collect |
| 8. Vehicle Make                            | 19. Staggered Fitment  | 31. Claiming 30 Day Trial  |
| 9. Vehicle Model                           | 20. Size/Ply           | 32. Dealer's Signature     |
| 10. Vehicle VIN Number                     | 21. Pattern            | 33. Owner-User's Signature |
| 11. Vehicle Usage                          | 22. Part/Material No.  |                            |
|  | 23. D.O.T. Number      |                            |

Weborder Form

**HANKOOK** Web Order system

WELCOME DEALER | PRODUCT | HELP DESK | CART | DASHBOARD | LOGOUT

ORDER    NATIONAL ACCOUNT    STATUS    REPORT    WARRANTY RETURN

**Warranty Return**

Create Warranty Return    Warranty Return Status

**Distributor**

Name: Address: Phone Number: Acct:

**Ship-To**

Ship-to: Address: Phone Number: Acct:

**Point Of Contact**

Name \*: Phone Number \*: Email:

**Vehicle Information**

Year: [dropdown]    Maker: [dropdown]    Model: [dropdown]    [Search]

Install Date: MM [dropdown] DD [dropdown] YYYY [dropdown]    Install Miles: [input]    Removal Miles: [input]    Total Miles: [input]

Vehicle usage: [dropdown]    Original equipment: [dropdown]

VIN number: [input]

**Tire Information**

Material No.	Size	Type	Ply	TBR Serial No.	D.O.T. Number	Barcode	PSI	32nds Remaining
[input]	[input]	[input]	[input]	[input]	[input]	[input]	[input]	[input]

For all claims for warranty adjustment, a warranty claim form must be filled out. Warranty claims can be completed online at **(eorder.hankooktire.com)** by logging in and accessing the "Warranty Return" section. Warranty claims can also be completed on paper Tire Warranty Claim Forms. Completed paper claim forms must be mailed to Hankook Tire America Corp. office. Do not ship tires to Hankook unless requested to OR you meet the minimum requirements of Hankook's TBR tire shipping policy (page 21). Hankook reserves the right to demand physical inspection of the tires on which adjustment is claimed.

## Freight Policy

1. At an accumulation of 6 truck and bus tires or greater OR you are requested to do so, Hankook Tire America Corp. will pay freight charges for all adjustment shipments. Tires shipped below this quantity or not at Hankook's request will be at your own expense. If sent collect, shipment will be refused and returned to you.
2. If you have a shipment ready that meets Hankook's shipping policy, please reach out to Hankook's Technical Services Team at [Warranty.Support@hankookn.com](mailto:Warranty.Support@hankookn.com), or at 1-800-426-5665, option 1
3. Average weights for adjustment are:
  - A. All Passenger Tires: 20 Pounds/Each
  - B. Light Truck Tires: 40 Pounds/Each
  - C. Medium Truck Tires: 110 Pounds/Each
  - D. Tube Passenger Tires: 2 Pounds/Each
  - E. Tube Truck Tires: 8 Pounds/Each
4. If you wish to have rejected tires returned to you, please indicate this in the comments section of the Hankook Tire Claim Form, and provide a point of contact for return shipment communication. Any tires that you request to be returned after a physical inspection will be shipped back to you at your expense. Otherwise, all tires not accompanied with a return request will be scrapped after inspected and rejected.

NOTE : Freight will not be paid by Hankook unless the above mentioned company is used. Exceptions will be taken only in cases where the freight carrier does not pick-up in your area, and you further obtain our approval in advance.

## General Terms & Policies

This Marketing Policy applies to all Hankook brand tires distributed by Hankook Tire America Corp. In this Marketing Policy, discounts and credits vary on the categories of products.

### Following categories are used:

1. PCR : Passenger Car Radial Tires (Including Z36: P235/75R15 XL, Dynapro AT & Dynapro AS: P-Metric, Radial RA08)
2. LTR : Light Truck Radial Tires
3. TBR : Medium Truck Radial Tires (Tires over 17.5")

**Credit Percentage Table 1**

Remaining Tread Depth (1/32")	ORIGINAL TREAD DEPTH (1/32")																				
	8.5	9.0	9.5	10.0	10.5	11.0	11.5	12.0	12.5	13.0	13.5	14.0	14.5	15.0	15.5	16.0	16.5	17.0	17.5	18.0	18.5
2.0	0	0	0	0	0	0	0	0	0	0	0	0	0	0	0	0	0	0	0	0	0
2.5	8	7	7	6	6	6	5	5	5	5	4	4	4	4	4	3	3	3	3	3	3
3.0	15	14	13	13	12	11	11	10	10	9	9	8	8	8	7	7	7	7	6	6	6
3.5	23	21	20	19	18	17	16	15	14	14	13	13	12	12	11	11	10	10	10	9	9
4.0	31	29	27	25	24	22	21	20	19	18	17	17	16	15	15	14	14	13	13	13	12
4.5	39	36	33	31	29	28	26	25	24	23	22	21	20	19	19	18	17	17	16	16	15
5.0	46	43	40	38	35	33	32	30	29	27	26	25	24	23	22	21	21	20	19	19	18
5.5	54	50	47	44	41	39	37	35	33	32	30	29	28	27	26	25	24	23	23	22	21
6.0	62	57	53	50	47	44	42	40	38	36	35	33	32	31	30	29	28	27	26	25	24
6.5	69	64	60	56	53	50	47	45	43	41	39	38	36	35	33	32	31	30	29	28	27
7.0	77	71	67	63	59	56	53	50	48	45	43	42	40	38	37	36	34	33	32	31	30
7.5	85	79	73	69	65	61	58	55	52	50	48	46	44	42	41	39	38	37	35	34	33
8.0	92	86	80	75	71	67	63	60	57	55	52	50	48	46	44	43	41	40	39	38	36
8.5	100	93	87	81	76	72	68	65	62	59	57	54	52	50	48	46	45	43	42	41	39
9.0		100	93	88	82	78	74	70	67	64	61	58	56	54	52	50	48	47	45	44	42
9.5			100	94	88	83	79	75	71	68	65	63	60	58	56	54	52	50	48	47	45
10.0				100	94	89	84	80	76	73	70	67	64	62	59	57	55	53	52	50	48
10.5					100	94	89	85	81	77	74	71	68	65	63	61	59	57	55	53	52
11.0						100	95	90	86	82	78	75	72	69	67	64	62	60	58	56	55
11.5							100	95	90	86	83	79	76	73	70	68	66	63	61	59	58
12.0								100	95	91	87	83	80	77	74	71	69	67	65	63	61
12.5									100	95	91	88	84	81	78	75	72	70	68	66	64
13.0										100	96	92	88	85	81	79	76	73	71	69	67
13.5											100	96	92	88	85	82	79	77	74	72	70
14.0												100	96	92	89	86	83	80	77	75	73
14.5													100	96	93	89	86	83	81	78	76
15.0														100	96	93	90	87	84	81	79
15.5															100	96	93	90	87	84	82
16.0																100	97	93	90	88	85
16.5																	100	97	94	91	88
17.0																		100	97	94	91
17.5																			100	97	94
18.0																				100	97
18.5																					100

**Credit Percentage Table 2**

Remaining Tread Depth (1/32")	ORIGINAL TREAD DEPTH (1/32")																					
	13	14	15	16	17	18	19	20	21	22	23	24	25	26	27	28	29	30	31	32		
2	0	0	0	0	0	0	0	0	0	0	0	0	0	0	0	0	0	0	0	0	0	
3	9	8	8	7	7	6	6	6	5	5	5	5	4	4	4	4	4	4	3	3	3	
4	18	17	15	14	13	13	12	11	11	10	10	9	9	8	8	8	7	7	7	7	7	
5	27	25	23	21	20	19	18	17	16	15	14	14	13	13	12	12	11	11	10	10	10	
6	36	33	31	29	27	25	24	22	21	20	19	18	17	17	16	15	15	14	14	13	13	
7	45	42	38	36	33	31	29	28	26	25	24	23	22	21	20	19	19	18	17	17	17	
8	55	50	46	43	40	38	35	33	32	30	29	27	26	25	24	23	22	21	21	20	20	
9	64	58	54	50	47	44	41	39	37	35	33	32	30	29	28	27	26	25	24	23	23	
10	73	67	62	57	53	50	47	44	42	40	38	36	35	33	32	31	30	29	28	27	27	
11	82	75	69	64	60	56	53	50	47	45	43	41	39	38	36	35	33	32	31	30	30	
12	91	83	77	71	67	63	59	56	53	50	48	45	43	42	40	38	37	36	34	33	33	
13	100	92	85	79	73	69	65	61	58	55	52	50	48	46	44	42	41	39	38	37	37	
14		100	92	86	80	75	71	67	63	60	57	55	52	50	48	46	44	43	41	40	40	
15			100	93	87	81	76	72	68	65	62	59	57	54	52	50	48	46	45	43	43	
16				100	93	88	82	78	74	70	67	64	61	58	56	54	52	50	48	47	47	
17					100	94	88	83	79	75	71	68	65	63	60	58	56	54	52	50	50	
18						100	94	89	84	80	76	73	70	67	64	62	59	57	55	53	53	
19							100	94	89	85	81	77	74	71	68	65	63	61	59	57	57	
20								100	95	90	86	82	78	75	72	69	67	64	62	60	60	
21									100	95	90	86	83	79	76	73	70	68	66	63	63	
22										100	95	91	87	83	80	77	74	71	69	67	67	
23											100	95	91	88	84	81	78	75	72	70	70	
24												100	96	92	88	85	81	79	76	73	73	
25													100	96	92	88	85	82	79	77	77	
26														100	96	92	89	86	83	80	80	
27															100	96	93	89	86	83	83	
28																100	96	93	90	87	87	
29																	100	96	93	90	90	
30																		100	97	93	93	
31																			100	97	97	
32																					100	



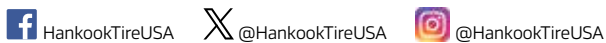

**Hankook Tire America Headquarters**

333 Commerce Street, Suite 600 Nashville, Tennessee 37201, USA T +1 615 432 0700 F +1 615 242 8709

[www.hankooktire.com](http://www.hankooktire.com)